



# ZCVRB47

DIRECT VENT LINEAR GAS FIREPLACE



THE ULTIMATE IN DESIGN, ENGINEERING & QUALITY

ZCVRB47N Zero Clearance Direct Vent Gas Fireplace – Natural Gas, ZCVRB47PL Porcelain Liners.



The ultimate in Zero Clearance Direct Vent Fireplaces for new home construction or renovation, and your best choice for installation anywhere throughout your home.

## ZCVRB47

DIRECT VENT LINEAR GAS FIREPLACE



### STANDARD FEATURES

- Hi/Low Millivolt or IPI valve system will operate during power failures.
- Decorative Bronze Glass
- Safety Screen Barrier

### OPTIONAL FEATURES

#### Fan Kit

Heat activated with variable speed control

#### Wall Mount Thermostat

Standard On/Off or Programmable 5 day (weekday) and 2 day (weekend)

#### Remote Control

On/Off, Thermostat On/Off, Thermostat On/Off modulating, Thermostat On/Off modulating and fan control

#### Universal Light Kit

Accent Lighting – Two Lamps

#### Porcelain Reflective Liner

#### Cannonballs

#### Enclosure Grill

Front or Side

#### Surround

Stainless Steel or Black



Safety Screen Barrier

### STYLING



Porcelain Reflective Liner



Multi-coloured Cannonballs



Decorative Ember Glass - Bronze

ZCVRB47N Zero Clearance Direct Vent Fireplace – Natural Gas, ZCVRB47PL Porcelain Liners. (Shown with Vented Chase Installation – top of chase left open)



THE ULTIMATE IN DESIGN, ENGINEERING & QUALITY

<b>Model</b>	ZCVRB47N/NE	ZCVRB47LP/LPE
<b>Fuel</b>	Natural	Propane
<b>Gas Control</b>	Millivolt / IPI	Millivolt / IPI
<b>Input Max.</b>	24,500 BTU	24,500 BTU
<b>Input Min.</b>	16,500 BTU	20,500 BTU
<b>FE (P.4.1-15)</b>	55.26% / 57.31%	55.01% / 57.10%
<b>Glass Size</b>	40 5/8" x 13 7/8"	40 5/8" x 13 7/8"
<b>Venting</b>	4/7" Flex or 4 x 6 5/8" Hard Pipe	

Warm up your favourite room with the beauty of a Linear Fireplace.

## VENTED CHASE OPTION

The chase of the appliance may be vented to achieve Cool Touch Walls or reduced Mantel Clearances. The following options are available to vent the chase:

- The top of the chase can be left open.
- A grill can be installed on the front of the chase.
- If the chase bumps out into the room, side grills can be installed on each side of the chase.

Minimum enclosure height for a vented chase is 70" from bottom of fireplace, ventilation of a 105 in<sup>2</sup> of minimum free air opening is required. Choose between our V46EG Enclosure Grill or Custom Grill (if custom grills are used the louvers cannot slope) or adequate ventilation opening as stated in the manual. Grill or opening must be within 2" of chase top/ceiling.

Framing to ceiling with open front 2-1/4" x 47"

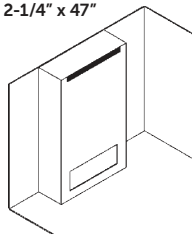

Open chase framing with enclosure min 1-1/4" below ceiling

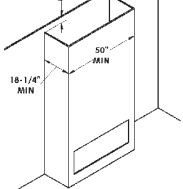

Framing to ceiling with vents at front and back

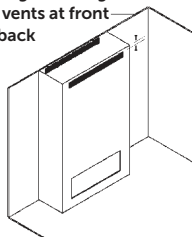

Framing to ceiling with front or side vents

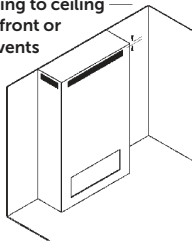

Framing to ceiling, minimum enclosure with front or side vents

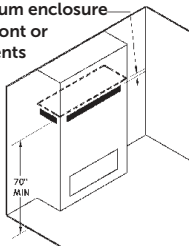

Minimum enclosure with front or side vents

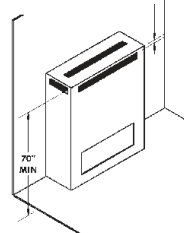

Minimum enclosure with front and back vents

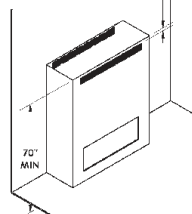

NOTE: To vent the fireplace chase, removal of vent shields from the fireplace is required.

### FIREPLACE DIMENSIONS

Width	Height	Depth
46 5/8"	38 5/8"	17 3/4"

### FRAMING DIMENSIONS

Width	Height	Depth
47"	38 3/4"	18 1/4"*

\* dependant of finishing material used.

## DIMENSIONS

### SURROUND

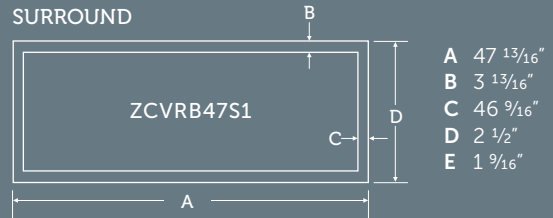

A	47 13/16"
B	3 13/16"
C	46 9/16"
D	2 1/2"
E	1 9/16"

### FRONT ENCLOSURE GRILL



A	44 5/8"
B	1 1/2"
C	1 1/2"
D	17 3/4"
E	1"
F	1 3/4"

### SIDE GRILL

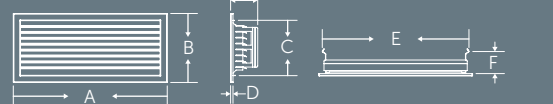

A	16 3/16"
B	7 1/4"
C	5 13/16"
D	1/4"
E	15 7/16"
F	2 5/16"

## SPECIFICATIONS (IN.)

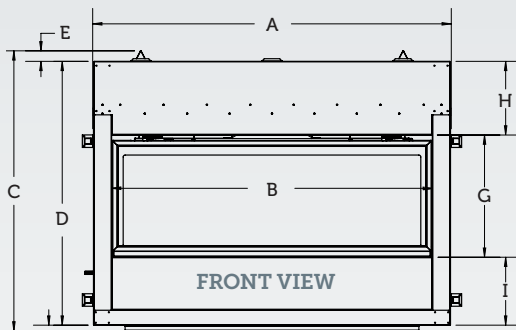

A	46 5/8"
B	41 5/8"
C	38 5/8"
D	35 11/16"
E	2 1/4"
F	3/4"
G	15 7/8"
H	11"
I	8 13/16"
J	34 5/8"
K	17 3/4"
L	11 1/16"
M	29 1/16"
N	31 11/16"
O	17 3/4"
P	5 11/16"
Q	2 1/8"
R	2 11/16"
S	3 3/16"

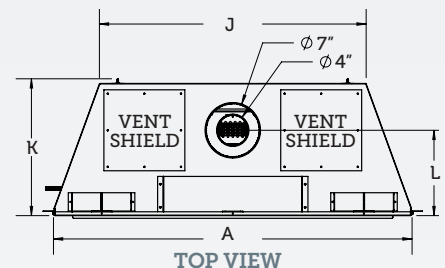
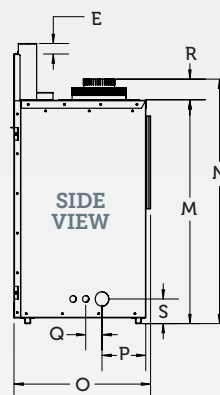





2340 Logan Avenue  
Winnipeg, Manitoba, Canada R2R 2V3  
Phone: (204) 632-1962 Fax: (204) 632-1960  
[www.kingsmanfireplaces.com](http://www.kingsmanfireplaces.com)

# ZCVRB47

DIRECT VENT LINEAR GAS FIREPLACE



Canada  
**ENERGUIDE**  
Look for the **EnerGuide**  
Gas Fireplace Energy  
Efficiency Rating in this brochure  
*Based on CSA P.4.1-15*

ZCVRB47N Zero Clearance Direct Vent Gas Fireplace  
– Natural Gas, ZCVRB47S1BL Surround – Black, RBCB1  
Cannonballs x 14, ZCVRB47PL Porcelain Liners.  
(Shown with V46EG Enclosure Grill Installation.)



\*Components may have to be ordered separately to create a complete unit. Discuss with your local Kingsman dealer for clarification.  
Kingsman Fireplaces maintains a program of continuous testing, refinement and improvements of all its products. Some aspect of units shown here may be changed at any time without notice or obligation. Certification: Model ZCVRB47 is certified to ANSI Z21.88-2017, vented gas fireplace heater.



CRAFTED ENTIRELY IN CANADA, EACH KINGSMAN FIREPLACE  
IS BUILT TO THE HIGHEST STANDARDS AND MADE TO LAST.

Printed in Canada  
01/19 – B102



**FOR CALIFORNIA RESIDENTS ONLY:**  
**WARNING!** This product can expose you to chemicals including Carbon Monoxide, that is an externally vented by-product of fuel consumption, which is [are] known to the State of California to cause birth defects or other reproductive harm. For more information, visit [www.P65Warnings.ca.gov](http://www.P65Warnings.ca.gov).